

DLFSCA and DLFLCA

OWNERS MANUAL

Cassette Ductless System – Sizes 09 to 48

TABLE OF CONTENTS

	PAGE
A NOTE ABOUT SAFETY	2
GENERAL	2
PART NAMES	3
FUNCTION BUTTONS	4
CLEANING, MAINTENANCE, AND TROUBLESHOOTING	11

NOTE TO EQUIPMENT OWNER:

Please read this Owner's Information Manual carefully before installing and using this appliance and keep this manual for future reference.

For your convenience, please record the model and serial numbers of your new equipment in the spaces provided. This information, along with the installation data and dealer contact information, will be helpful should your system require maintenance or service.

UNIT INFORMATION

Model # _____

Serial # _____

INSTALLATION INFORMATION

Date Installed _____

DEALERSHIP CONTACT INFORMATION

Company Name: _____

Address: _____

Phone Number: _____

Technician Name: _____

A NOTE ABOUT SAFETY

Any time you see this symbol  in manuals, instructions and on the unit, be aware of the potential for personal injury. There are three levels of precaution:

DANGER identifies the most serious hazards which will result in severe personal injury or death.

WARNING signifies hazards that could result in personal injury or death.

CAUTION is used to identify unsafe practices which could result in minor personal injury or product and property damage.

NOTE is used to highlight suggestions which will result in enhanced installation, reliability, or operation.



WARNING

PERSONAL INJURY, DEATH AND / OR PROPERTY DAMAGE HAZARD

Failure to follow this warning could result in personal injury, death or property damage.

Improper installation, adjustment, alteration, service, maintenance, or use can cause explosion, fire, electrical shock, or other conditions which may cause personal injury or property damage. Consult a qualified installer, service agency, or your distributor or branch for information or assistance. The qualified installer or service agency must use factory-authorized kits or accessories when modifying this product.

Read and follow all instructions and warnings, including labels shipped with or attached to unit before operating your new air conditioner.

GENERAL

The cassette fan coil unit provides quiet, maximum comfort. In addition to cooling and/or heating, the cassette fan coil unit matched with an outdoor condensing unit filters and dehumidifies the air in the room to provide maximum comfort.

IMPORTANT: The cassette fan coil unit should be installed by authorized personnel only; using approved tubing and accessories. If technical assistance, service or repair is needed, contact the installer. The cassette fan coil unit can be set up and operated from the remote control (provided). **If the remote is misplaced, the system can be operated from the “Auto” setting on the unit.**

Operating Modes

The cassette fan coil unit has five operating modes:

- Fan only
- Auto
- Heating (heat pump models only)
- Cooling
- Dehumidification (DRY)

Fan Only

In the **FAN ONLY** mode, the system filters and circulates the room air without changing room air temperature.

Auto

In the **AUTO** mode, the system automatically cools or heats the room according to the user-selected set point.

Heating

In the **HEATING** mode, the system heats and filters the room air.

Cooling

In the **COOLING** mode, the system cools, dries and filters the room air.

Dehumidification (DRY)

In the **DEHUMIDIFICATION** mode, the system dries, filters and slightly cools the room air temperature. This mode prioritizes air dehumidification but it *does not* take the place of a dehumidifier.

Wireless Remote Control

The remote control transmits commands to set up and operate the system. The control has a window display panel that displays the current system status. The control can be secured to a surface when used with the mounting bracket provided.

Wired Remote Control (Optional)

PART NAMES

Table 1—Parts List

PART NO.	PART NAME
1	Air flow louver (at air outlet)
2	Condensate Lift pump
3	Drain pipe (Field Supplied)
4	Air outlet
5	Air filter (inside grille/ceiling panel)
6	Air inlet
7	Grille/Ceiling panel (Required – sold separately)
8	Display panel
9	Wireless remote controller
10	Refrigerant pipe (Field Supplied)

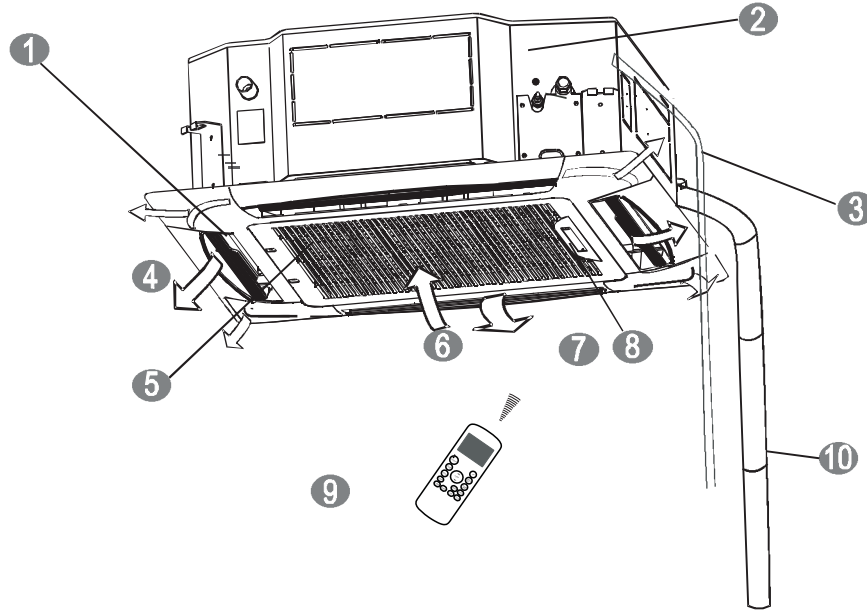

Fig. 1 – Parts List



88 SELECTED TEMPERATURE / SELF-DIAGNOSTIC CODES indicator

DEFROST indicator
Illuminates when the coil is warming up to prevent cold blow or when the unit goes into defrost mode.

OPERATION indicator
This indicator flashes once per second after power is on and illuminates when the unit is in operation.

TIMER indicator
Illuminates during TIMER operation

Fig. 2 – Display Panel

A14356

BUTTON FUNCTIONS

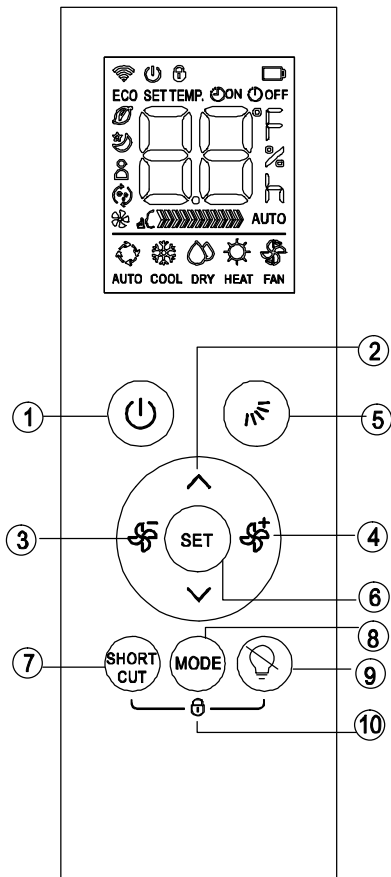

Fig. 3 – Remote Controller Buttons

1. ON/OFF Button (⏻)

This button turns the unit ON and OFF.

2. UP Button (▲) and DOWN Button (▼)

Press these buttons to increase or decrease the set temperature or Timer setting hours.

3. Fan Button (🌀)

Used to select the fan speed in four steps:
HIGH → MED → LOW → AUTO

NOTE:

Hold down this button for at least 2 seconds to activate/cancel Silent mode. Due to low frequency operation of the compressor, it may result in insufficient cooling and heating capacity.

4. Fan Button (🌀)

Used to select the fan speed in four steps:
AUTO → LOW → MED → HIGH

You cannot switch the fan speed in AUTO or DRY mode.

NOTE: Hold down this button for at least 2 seconds to activate/cancel Turbo mode. Turbo function enables the unit to reach the preset temperature at cooling or heating operation in the shortest time. If the indoor unit does not support this function, there is no corresponding operation happening when this button is pressed.

5. Swing Button (🌀)

Used to stop or start horizontal louver movement. Hold down this button for 2 seconds to start/stop vertical louver movement.

6. Set Button

Used to initiate the following functions in the sequence below, in conjunction with the ▲ and ▼ buttons.

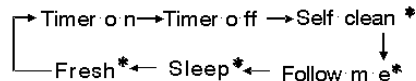

(* Indicates optional functions)

Press the SET button to select the desired function. The selected symbol will flash on the display area. Then press the ▲ or ▼ button to confirm.

SLEEP Function (🌀)

This function maintains the most comfortable temperature and saves energy. It is available in COOL, HEAT, or AUTO modes only.

* FRESH Function (🌀)

Not Available on this Unit.

* SELF CLEAN Function (🌀) (optional)

In SELF CLEAN mode, the unit automatically cleans and dries the Evaporator and keeps it fresh for the next operation.

* FOLLOW ME Function (🌀) (optional)

When the Follow Me function is activated, the remote display is the actual temperature at its location. The remote control will send this signal to the unit every 3 minutes until the FOLLOW ME button is pressed again.

7. Shortcut Button

- Used to restore the current settings or resume previous settings.
- The first time connecting to power, if the SHORTCUT button is pressed, the unit will operate in AUTO mode, 80°F, and the fan speed is Auto.
- Push this button when the remote controller is on, and the system automatically reverts back to the previous settings including operating mode, setting temperature, fan speed level, and sleep feature (if activated).
- If this button is pressed more than 2 seconds, the system automatically restores the current operation settings including operating mode, setting temperature, fan speed level, and sleep feature (if activated).

8. Mode Button

Press this button to modify the unit mode in the following sequence:

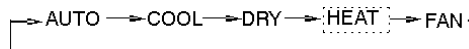

NOTE: Do not select HEAT mode if the unit is the Cooling Only type. Heat mode is not supported by this type of unit.

9. LED Button (💡)

Press this button to turn ON/OFF the indoor screen display.

NOTE: Pressing and holding the LED and SWING buttons together for 3 seconds will alternate the temperature display between °C and °F scales.

10. LOCK Function

Press SHORT CUT and LED buttons together to lock or unlock the keyboard.

MODE DISPLAY

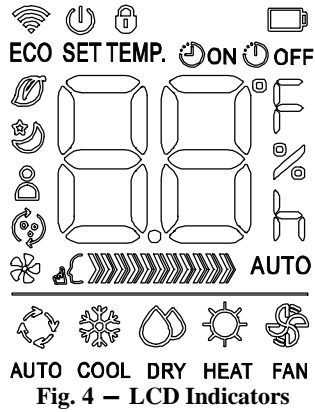

Fig. 4 – LCD Indicators



Fig. 5 – Modes

	Displayed when data transmitted
	Displayed when remote controller is ON
	Battery display (low battery detection)
	Indicated LOCK feature is activated
ECO	Displayed in ECO mode operation
	Displayed when TIMER ON time is set
	Displayed when TIMER OFF time is set
	Show set temperature, room temperature, or time under TIMER setting
	Indicates that the air conditioner is operating in Follow me mode
	Displayed in Fresh operation
	Displayed in Self clean operation
	Displayed when Silent feature is activated
	Displayed in Sleep Mode operation
Fan speed indication	
	Low speed
	Medium speed
	High speed
	AUTO Auto fan speed

Fig. 6 – Mode Display

⚠ CAUTION

EQUIPMENT DAMAGE HAZARD

Failure to follow this caution may result in equipment damage. Handle the control with care and avoid getting the control wet.

IMPORTANT: The remote control can operate the unit from a distance of up to 26 ft. (8 m) as long as there are no obstructions.

When the timer function is used, the remote control should be kept in the vicinity of the fan coil (within 26 ft. / 8 m).

The remote control can perform the following basic functions:

- Turn the system ON and OFF
- Select operating mode
- Adjust room air temperature set point and fan speed
- Adjust airflow direction

Refer to the *Remote Control Function* section for a detailed description of all the capabilities of the remote control.

Battery Installation

Two AAA 1.5v alkaline batteries (included) are required for operation of the remote control.

To install or replace batteries:

1. Slide the back cover off the control to open the battery compartment.
2. Insert batteries. Follow the polarity markings inside the battery compartment.
3. Replace the battery compartment cover.

NOTE:

1. When replacing batteries, do not use old batteries or a different type battery. This may cause the remote control to malfunction. If the remote is not going to be used for several weeks, remove the batteries. Otherwise battery leakage may damage the remote control.
2. The average battery life under normal use is about 6 months.
3. Replace the batteries when there is no audible beep from the indoor unit or if the Transmission Indicator fails to light.
4. When batteries are removed, the remote control erases all programmed settings. The control must be reprogrammed after insertion of new batteries.

Remote Control Operation – Quick Start

NOTE: When transmitting a command from the remote control to the unit, be sure to point the control toward the right side of the unit. The unit confirms receipt of a command by sounding an audible beep.

1. Turn the unit on by pressing **ON/OFF**.
2. If there is a preference for °C rather than °F (default), press and hold the LED and SWING buttons together for approximately 3 seconds.
3. Select the desired mode by pushing **MODE**.



Fig. 7 – Modes

4. Select the temperature set point by pointing the control toward the unit and pressing the increase/decrease temperature set point buttons until the desired temperature appears on screen.
5. Select the desired fan speed by pressing the **FAN** button.

NOTE: If the unit is operating in **DRY** or **AUTO** mode, the fan speed will be automatically set.

6. Set the airflow direction. When the unit is turned on, the louvers default to the cooling or heating position. The user can adjust the louver position of the louvers by pressing **SWING** or have continuous louver movement by pressing **SWING**.

Manual Operation

If the remote control is lost, damaged, or the batteries are exhausted, the **MANUAL** button can be used to run the unit.

When the **MANUAL** button is pressed once, the **AUTO** mode takes affect (heat or cool). When this button is pressed twice, the system enters the **TEST** mode and runs for 30 minutes in the **COOLING** mode (it runs in the **AUTO** mode afterward). When pressed three times, the system turns OFF.

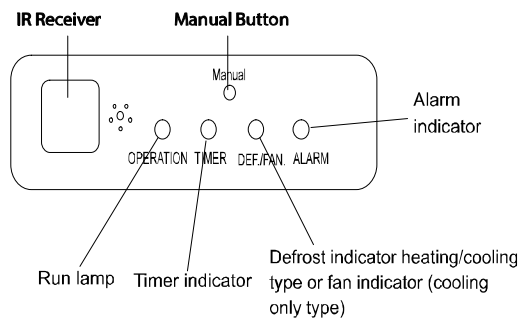

Fig. 8 – Display Panel

The set conditions of manual operation are as follows:

- Preset set point: 76°F (24°C)
- Fan speed: **AUTO**
- Discharge air direction: Pre-set position based on operation in the **COOL** or **HEAT** mode.

REMOTE CONTROL FUNCTIONS

Pressing the On/Off Button

When the air conditioner is not in operation, the remote control displays the last set point and mode.

- Press **ON/OFF** to start the unit.
 - The unit starts in the last operating mode and set point. The **ON/OFF** indicator appears.
- Press **On/Off** to stop the unit.
 - All the indicator lights on the unit go out, and the remote control displays the set point and mode.

NOTE: If **ON/OFF** is pressed too soon after a stop, the compressor will not start for 3 to 4 minutes due to the inherent protection against frequent compressor cycling. The unit only emits an audible beep when the signals are received correctly.

Selecting an Operating Mode

Select **OPERATING** mode to select one of the available modes.

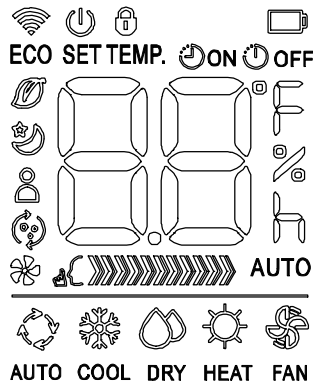

Fig. 9 – Display

Setting the Room Temperature Set Point

Press the increase temperature set point ▲ and decrease ▼ buttons to raise or lower the temperature.

The unit confirms the signal receipt with a beep and the value of the set temperature appears on the display and changes accordingly. The temperature can be set between 62°F (17°C) and 86°F (30°C) in increments of 1°F or 1°C.

NOTE: In the **COOLING** mode, if the temperature selected is higher than the room temperature, the unit will not start. The same applies for the **HEATING** mode if the selected temperature is lower than the room temperature.

Selecting the Fan Speed

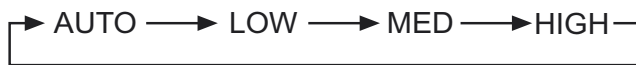

Fig. 10 – Fan Speeds

The fan speed can be selected by pressing **FAN**.

NOTE: When the unit is on, the fan runs continuously in cooling or heating. When in heating, there might be situations where the fan will slow down or shut off to prevent cold blow.

Selecting the Louver Position

To optimize comfort, the louvers operate in a preset range as shown in the following figure.

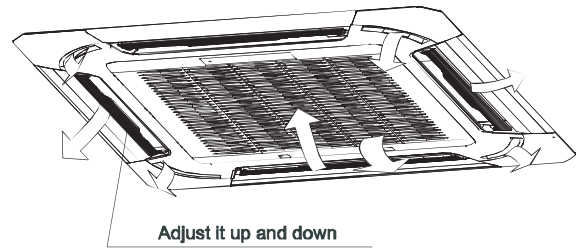

Fig. 11 – Louver Position

The louvers can be adjusted by pressing **SWING** on the remote control. The louvers can be set to remain stationary or move continuously by pressing **SWING**. The louver position is stored in the settings, however it is deactivated when the **TURBO** or **MANUAL** settings are set, or when a power interruption occurs.

Air Direction

Press **SWING** repeatedly to choose one of the louver positions. Every time **SWING** is pushed, the louvers swing by 30 degrees.

NOTE: Always use the remote control to adjust the louver position, otherwise abnormal operation may occur. If the horizontal louver is manually adjusted out of its range, power the unit off and then back on again.

Auto Swing

For automatic louver swing, push **SWING**.

Sleep Mode

The **SLEEP** mode is used to conserve energy and can be used when the unit is in the **COOL**, **HEAT** or **AUTO** mode only.

Cool Mode

- Push the **SET** button. After 1 hour the set point raises by 1.8°F (1°C). After another hour, the set point raises by another 1.8°F (1°C) and the fan runs in a low speed. The unit shuts off 5 hours after setting the **SLEEP** mode. The **SLEEP** mode cancels if either the **MODE**, **TEMP**, **FAN**, **TIMER**, or **ON/OFF** buttons on the remote control are pressed.

Heat Mode

Same as the **COOLING** mode however the set points are lowered by 1.8°F (1°C).

Turbo Mode

Use the **FAN +** mode to cool or heat the room rapidly.

- Press **TURBO** (an audible “beep” is heard if the indoor unit supports this function). The fan runs on super high speed. The **TURBO** mode terminates automatically 20 minutes after pressing **TURBO**. It can be terminated immediately by pressing **FAN +** again. When the **TURBO** mode is terminated, the unit reverts to the original setting.

Self Clean Mode

Press the **SET** button to activate or deactivate the self-cleaning function. Under this function, the air conditioner automatically cleans and dries the evaporator. The cleaning cycle takes 30 minutes, after which the unit turns off automatically. Pressing **SELF CLEAN** on the middle of the cycle cancels the operation and turns off the unit. This function can be activated only on **COOL** or **DRY** mode.

Follow Me Mode

Press the **SET** button to activate or deactivate this function. Under this setting, the temperature that appears in the remote control is the actual temperature at its location. The remote control sends this signal to the air conditioner every 3 minutes. This function is not available for **DRY** and **FAN** modes.

Freeze Protection Mode

The indoor unit displays **FP**.

NOTE: This function is only available in the heating mode.

Under this function, the unit operates at high fan speed and the coil temperature automatically sets to 46°F (8°C). This mode can also be deactivated by pressing the **ON/OFF**, **SLEEP**, **MODE**, **FAN**, or either **TEMP** buttons.

Silence Mode

NOTE: The Silence Mode (SLC) is not available.

LED Light

Press **LED** to turn the display light on and off.

Resetting the Remote Control

If the batteries in the remote control are removed, the current settings will be cancelled and the control returns to the initial settings and will be in standby mode. Push **TURBO** to activate.

Time Delay

If **ON/OFF** is pressed too soon after a stop, the compressor will not start for 3 to 4 minutes due to the inherent protection against frequent compressor cycling. The unit only emits an audible beep when the signals are received correctly.

Heating Features

If the unit is in the heating mode, there is a delay when the fan starts. The fan starts only after the coil is warmed up to prevent cold blow.

Auto Defrost Operation

In **HEATING** mode, if the outdoor coil is frosted, the indoor fan and outdoor fan turns off while the system removes the frost on the outdoor coil. The system automatically reverts to normal operation when frost is removed from the outdoor unit.

Auto Start

If the power fails while the unit is operating, the unit stores the operating condition, and the unit starts the stored operation automatically when the power is restored.

AUTO OPERATION

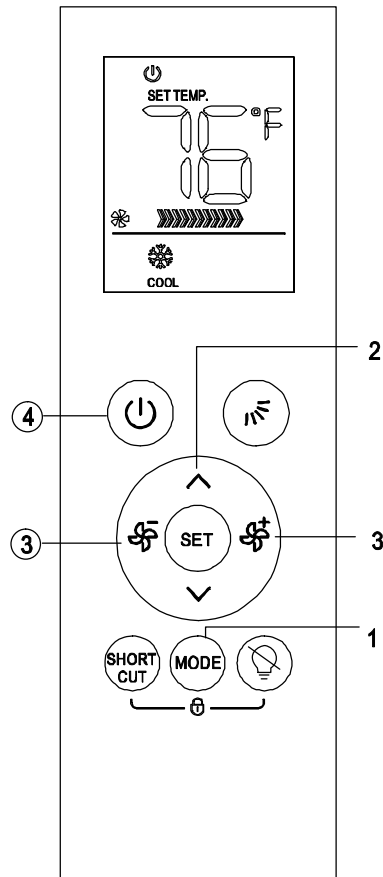

Fig. 12 – Remote Controller Buttons for Auto Operation

Ensure the unit is plugged in and power is available. The **OPERATION** indicator on the display panel of the indoor unit starts flashing.

1. Press the **MODE** button to select Auto.
2. Press the **UP/DOWN** button to set the desired temperature. The temperature can be set within a range of 62°F~86°F in 1°F increments.
3. Press the **ON/OFF** button to start the unit.

NOTE:

- In Auto mode, the unit can logically choose the mode of Cooling, Fan, and Heating by sensing the difference between the actual ambient room temperature and the setting temperature on the remote controller.
- In Auto mode, you cannot switch the fan speed. It has already been automatically controlled.
- If Auto mode is not comfortable for you, the desired mode can be manually selected.

Cooling /Heating/Fan Operation

Ensure the unit is plugged in and power is available.

1. Press the **MODE** button to select **COOL**, **HEAT** (cooling and heating models only), or **FAN** mode.
2. Press the **UP/DOWN** buttons to set the desired temperature. The temperature can be set within a range of 62°F~86°F in 1°F increments.
3. Press the **FAN** button to select the fan speed in four steps– Auto, Low, Med, or High.
4. Press the **ON/OFF** button to start the unit.

NOTE: In **FAN** mode, the setting temperature is not displayed on the remote controller and you are not able to control the room temperature. In this case, only steps 1, 3, and 4 may be performed.

DEHUMIDIFYING OPERATION

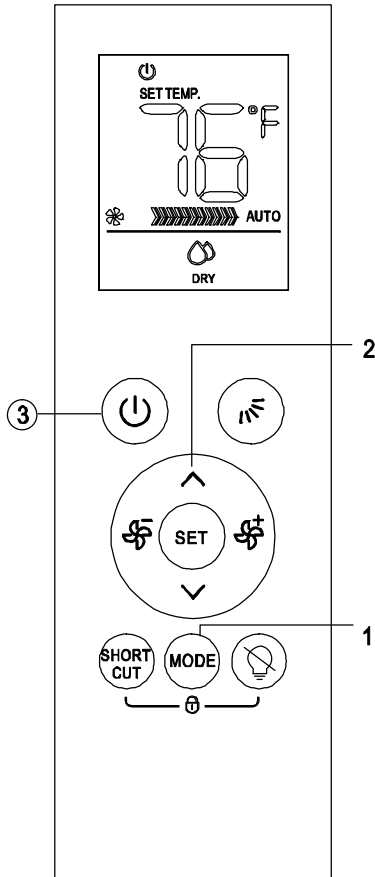

Fig. 13 – Remote Controller Buttons for Dehumidifying Operation

Ensure the unit is plugged in and power is available. The OPERATION indicator on the display panel of the indoor unit starts flashing.

1. Press the MODE button to select DRY mode.
2. Press the UP/DOWN buttons to set the desired temperature. The temperature can be set within a range of 62°F~86°F in 1°F increments.
3. Press the ON/OFF button to start the unit.

TIMER OPERATION

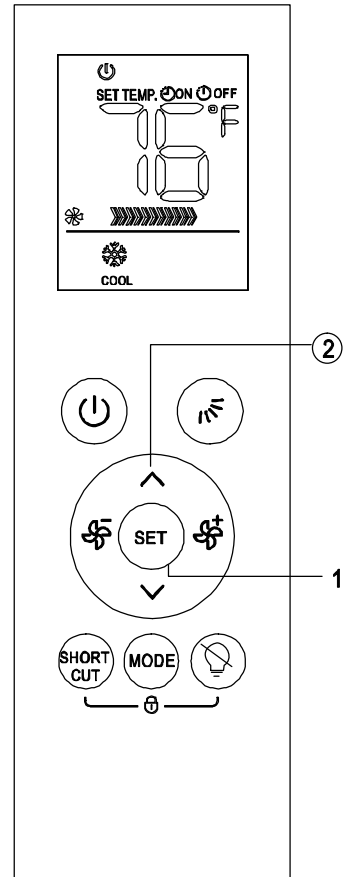

Fig. 14 – Remote Controller Buttons for Timer Operation

Press the SET button can set the auto-on/off time of the unit.

Set the Auto-On Time

1. Press the SET button

The Timer on indicator **ON** displays and flashes. The last Auto-on setting time and the signal “h” shows on the LCD display area. Now it is ready to reset the Auto-on time to START the operation.

2. Press the **^** or **v** button to set desired Auto-On time. Each time you press the button, the time increases/decreases by half an hour between 0 and 10 hours and by one hour between 10 and 24 hours.
3. Once the desired time is established, there will be a three second delay before the remote controller transmits the signal to the unit. Then, the “h” signal disappears, and the Timer On indicator will remain on and the set temperature will re-appear on the LCD display window.

Set the Auto-Off Time

1. Press the SET button until the Timer On indicator **OFF** displays and flashes. The last Auto-off setting time and the “h” signal will be shown on the LCD display area. Now it is ready to reset the Auto-off time to STOP the operation.
2. Press the **^** or **v** button to set desired Auto-On time. Each time you press the button, the time increases/decreases by half an hour between 0 and 10 hours and by one hour between 10 and 24 hours.
3. Once the desired time is established, there will be a three second delay before the remote controller transmits the signal to the unit. Then, the “h” signal disappears, and the Timer Off indicator will remain on and the set temperature will re-appear on the LCD display window.

Timer Setting Example

Timer ON

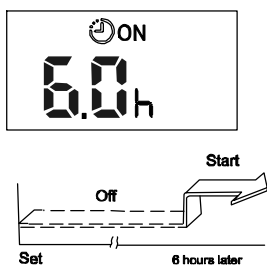

Fig. 15 – Timer ON Setting Example

(Auto-ON Operation)

The TIMER ON feature is useful when you want the unit to turn on automatically before you return home. The unit will automatically start operating at the set time.

Example

To start the unit in 6 hours.

1. Press the SET button to select TIMER ON.
The last setting of starting operation time and signal "h" will show on the display area.
2. Press the \wedge or \vee button to display "6.0h" on the TIMER ON display of the remote controller.
3. Wait for three seconds and the digital display area will show the temperature again. The ON indicator remains on and this function is activated.

Timer OFF

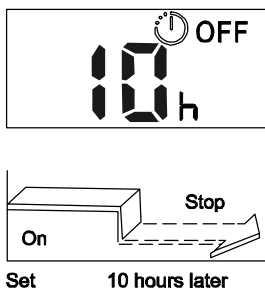

Fig. 16 – Timer OFF Setting Example

(Auto-OFF Operation)

The TIMER OFF feature is useful when you want the unit to turn off automatically after you go to bed. The unit will stop automatically at the set time.

Example

To stop the unit in 10 hours.

1. Press the SET button to select TIMER OFF.
The last setting of stopping operation time and the signal "h" will show on the display area.
2. Press the \wedge or \vee button to display "10h" on the TIMER OFF display of the remote controller.
3. Wait for three seconds and the digital display area will show the temperature again. The OFF indicator remains on and this function is activated.

Combined Timer

(Setting both ON and OFF timers simultaneously)

TIMER OFF → TIMER ON

(On → Stop → Start operation)

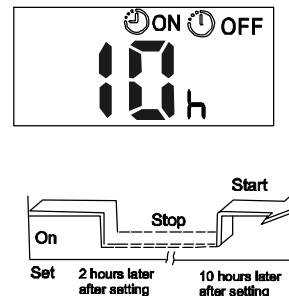

Fig. 17 – Combined Timer (Timer OFF → Timer ON)

This feature is useful when you want to stop the unit in the evening, and start it again in the morning.

Example

To stop the unit 2 hours after setting and start it again 10 hours after setting.

1. Press the SET button to select TIMER OFF.
2. Press the \wedge or \vee button to display "2.0h" on the TIMER OFF display.
3. Press the SET button to select TIMER ON.
4. Press \wedge or \vee button to display "10h" on the TIMER ON display.
5. Wait three seconds and the digital display area will show the temperature again. The ON and OFF indicators remain on and this function is activated.

TIMER ON → TIMER OFF

(Off → Start → Stop operation)

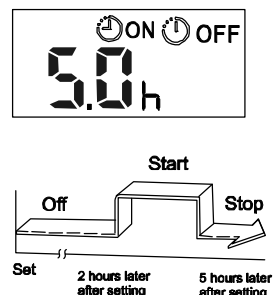

Fig. 18 – Combined Timer (Timer ON → Timer OFF)

This feature is useful when you want to start the unit before waking up and stopping it after leaving the house.

Example

To start the unit 2 hours after setting and stop it 5 hours after setting.

1. Press the SET button to select TIMER ON.
2. Press the \wedge or \vee button to display "2.0h" on the TIMER ON display.
3. Press the SET button to select TIMER OFF.
4. Press the \wedge or \vee button to display "5.0h" on the TIMER OFF display.
5. Wait three seconds, and the digital display area will show the temperature again.
The ON and OFF indicators remain on and this function is activated.

CLEANING, MAINTENANCE, AND TROUBLESHOOTING

⚠ CAUTION

ELECTRICAL SHOCK HAZARD

Failure to follow this caution may result in personal injury or death.

Always turn off power to the system before performing any cleaning or maintenance to the system. Turn off the outdoor disconnect switch located near outdoor unit. Be sure to disconnect indoor unit if on a separate switch

⚠ CAUTION

EQUIPMENT DAMAGE/OPERATION HAZARD

Failure to follow this caution may result in equipment damage or improper unit operation.

Operating the system with dirty air filters may damage the indoor unit and could cause reduced cooling performance, intermittent system operation, frost build-up on indoor coil or blown fuses.

PERIODIC MAINTENANCE

Periodic maintenance is recommended to ensure proper operation of the unit. Recommended maintenance intervals vary depending on the installation environment, e.g., dusty zones, etc. Refer to Table 2.

⚠ CAUTION

CUT HAZARD

Failure to follow this caution may result in personal injury.

The coil fins are very sharp. Use caution when cleaning.

Always wear safety protection.

Cleaning the Coil

Clean the coil at the beginning of each cooling season, or when necessary. Use a vacuum cleaner or a long-bristle brush to avoid damage to the coil fins.

Air Filters

Remove and clean the air filters once a month.

- The air filter can prevent the dust or other particulates from entering the unit. In case of blockage of the filter, the working efficiency of the unit may greatly diminish. Therefore, the filter must be cleaned once every two weeks during long periods of use.
- If the unit is installed in a dusty place, clean the air filter frequently.
- If the accumulated dust is too heavy to be cleaned, replace the filter with a new one.

NOTE: If air filters show signs of excessive wear or are torn, they must be replaced. Contact your local dealer for replacement filters.

1. Open the return-air grille by pressing the grille latches towards the center of the grille.

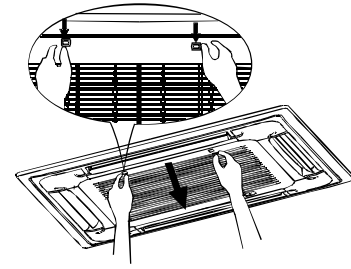

Fig. 19 – Press the grille latches

A150647

2. Bend the filter slightly and remove it.
3. Vacuum the filter.

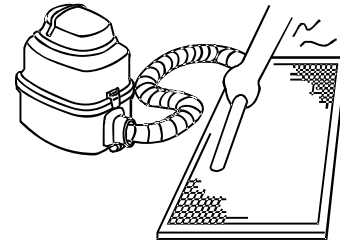

Fig. 20 – Vacuum the air filter

A150648

4. Clean the filter with warm water.
 - a. A vacuum cleaner or pure water may be used to clean the air filter. If the dust accumulation is heavy, please use a soft brush and mild detergent to clean it.
 - b. The air-in side should face up when using vacuum cleaner.
 - c. The air-in side should face down when using water.

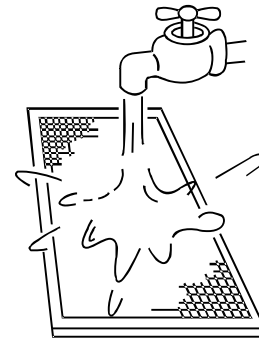

Fig. 21 – Clean filter with warm water

A150649

5. Shake the filter to remove excess water and dry thoroughly.
6. Allow the filter to dry in a cool place.



CAUTION

EQUIPMENT DAMAGE HAZARD

Do not dry out the air filter in direct sunlight or with direct heat or flame.

7. Replace the filter.
8. Press the grille latches towards the center to secure them and close the Return Air Grille.



CAUTION

- Before you clean the air conditioner, be sure the power supply is off.
- Check if the wiring is not broken off or disconnected.
- Use a dry cloth to wipe the indoor unit and remote controller.
- A wet cloth may be used to clean the indoor unit if it is very dirty.
- Never use a damp cloth on the remote controller.
- Do not use a chemically treated duster for wiping or leave such material on the unit for long. Doing so may damage or fade the unit surface.
- Do not use benzene, thinner, polishing powder, or similar solvents for cleaning. These may cause the plastic surface to crack or deform.

Maintenance after a Long Stop Period (at the beginning of the season)

- Check and remove everything that might be blocking inlet and outlet vents of indoor units and outdoor units.
- Clean air filters and casings of indoor units. Refer to "Cleaning the Air Filter" for details on how to proceed and make sure to install the cleaned air filters back in the same position.
- Turn on the power at least 12 hours before operating the unit to ensure smoother operation. As soon as the power is turned on, the remote controller displays appear.

Maintenance before a Long Stop Period (at the end of the season)

- Let the indoor units run in fan only operation for about half a day to dry the interior of the units.
- Clean the air filters and casings of the indoor units. Refer to "Cleaning the Air Filter" for details on how to proceed. Be sure to install cleaned air filters back in the same position.



CAUTION

EQUIPMENT DAMAGE HAZARD

Failure to follow this caution may result in equipment damage.

When cleaning the front panel, do not use water hotter than 105°F (40.6°C) and do not pour water onto the fan coil. Do not use abrasive or petroleum based cleaners as they may damage the front panel.

Indoor Unit Grille

To clean the grille on the indoor unit, wipe the outside with a soft, dry cloth.

PREPARING FOR EXTENDED SHUTDOWN PERIOD

Clean the filters and reposition them in the unit. Operate the unit in Fan only mode for 12 hours to dry all internal parts.

Turn main power supply off and remove batteries from the remote control.

SYSTEM OPERATION RECOMMENDATIONS

The items outlined in the following list help to assure proper system operation:

- Replace both remote control batteries at the same time.
- Point the remote control toward the unit display panel when transmitting a command.
- Keep doors and windows closed while unit is operating.
- Contact an authorized service representative if a problem arises that cannot be easily resolved.
- Do not perform cleaning or maintenance activities while the unit is on.
- Keep the display panel on the unit away from direct sunlight and heat as this may interfere with remote control transmissions.
- Do not block air intakes and outlets on the indoor or outdoor units.

ENERGY SAVING RECOMMENDATIONS

The following recommendations will add greater efficiency to the ductless system:

- Select a comfortable thermostat setting and leave it at chosen setting. Avoid continually raising and lowering the setting.
- Keep the filter clean. Frequent cleaning may be necessary depending on indoor air quality.
- Use drapes, curtains or shades to keep direct sunlight from heating the room on very hot days.
- Limit the unit's run time by using the **TIMER** function.
- Do not obstruct the air intake on the front panel.
- Turn on the air conditioning unit before the indoor air becomes too uncomfortable.

Troubleshooting

Refer to Table 3 before contacting your local dealer.

Table 2—Periodic Maintenance

INDOOR UNIT	EVERY MONTH	EVERY 6 MONTHS	EVERY YEAR
Clean Air Filter* Change Remote Control Batteries	•		•
OUTDOOR UNIT	EVERY MONTH	EVERY 6 MONTHS	EVERY YEAR
Clean Outdoor Coil from Outside Clean Outdoor Coil from Inside† Blow Air Over Electric Parts† Check Electric Connection Tightening† Clean Fan Wheel† Check Fan Tightening† Clean Drain Pan†		•	• • • • •

* Increase frequency in dusty zones.

† Maintenance to be carried out by qualified service personnel. Refer to the Installation Manual

Table 3—Troubleshooting

PROBLEM	POSSIBLE CAUSE	SOLUTION
Unit/System Does Not Work	<ul style="list-style-type: none"> The circuit breaker has tripped or a fuse has blown. Power failure. Diagnostic lights illuminate.* Voltage is too low. 	<ul style="list-style-type: none"> Reset the circuit breaker or replace the fuse with the specified replacement fuse. Restart operation when the power is restored. Call your service representative. Call your service representative.
Cooling is Not Working Properly	<ul style="list-style-type: none"> The filter is blocked with dust. Temperature is not set properly. A window or door is open. The outdoor unit is obstructed. The fan speed is too low. Operation mode is in Fan instead of COOL. 	<ul style="list-style-type: none"> Clean the air filter. Check the temperature and reset if necessary. Close the window or door. Remove the obstruction. Change the fan speed selection. Change operating mode to COOL or reset the unit.
Heating is Not Working Properly	<ul style="list-style-type: none"> The filter is blocked with dust. Temperature is set too low. A window or door is open. The outdoor unit is obstructed. 	<ul style="list-style-type: none"> Clean the air filter. Check the temperature and reset if necessary. Close the window or door. Remove the obstruction.
Unit Stops During Operation	<ul style="list-style-type: none"> The OFF timer is not operating correctly. Diagnostic lights illuminate.* 	<ul style="list-style-type: none"> Restart the operating mode. Call your service representative.

* Diagnostic lights are a combination of lights that will illuminate in the display area on the unit. They are a combination of the lights you see during normal operation.

